

## EFFECT OF PROCESS CONDITIONS ON THE PHYSICO-CHEMICAL PROPERTIES OF GROUNDNUT OIL EXTRACTED WITH A VERTICAL SCREW JACK

Michael Mayokun **ODEWOLE**<sup>1\*</sup>, Samuel Kehinde **OYENIYI**<sup>2</sup> and Emmanuel Babajide **ADESOYE**<sup>3</sup>

<sup>1</sup>Department of Food and Bioprocess Engineering, Faculty of Engineering and Technology, University of Ilorin, P.M.B. 1515, Ilorin, Kwara State, Nigeria;

<sup>2</sup>Department of Agricultural and Environmental Engineering, Faculty of Technology, University of Ibadan, Ibadan, Oyo State, Nigeria;

<sup>3</sup>Department of Agricultural and Biosystems Engineering, Faculty of Engineering and Technology, University of Ilorin, P.M.B. 1515, Ilorin, Kwara State, Nigeria

\*Corresponding Author: E-mails: <sup>1,\*</sup> [odewole2005@yahoo.com](mailto:odewole2005@yahoo.com)

### Abstract

The effect of two process conditions (temperature and heating time) on some physico-chemical properties (pH value, Free Fatty Acid (FFA), saponification value, acid value, refractive index and viscosity) of groundnut oil extracted with a vertical screw jack was investigated. The following equipment were used: a vertical screw jack, digital weighing balance (OHAUS CL Series, Model CL 201, China, accuracy: 0.1), stop watch (Nokia X2-01), and oil bottles and containers. Three levels of temperature (50°C, 60°C and 70°C) and two levels of heating time (5 min and 10 min) were used for processing the groundnut before oil extraction. The experimental design used was 3 × 2 factorial experiment in a Randomized Completed Block Design (RCBD) with three replicates. A uniform experimental sample of 100 g per run of prepared groundnut seeds was used as feedstock for oil extraction operation. Samples of oil extracted were analysed for the physico-chemical properties with AOAC (2002) standard procedures. Results showed that the physico-chemical properties of extracted oil decreased with increase in temperature from 50°C to 60°C and heating times but later increased at 70°C. The range of values of physico-chemical properties obtained were: 5.05-5.45 for pH value, 3.32-3.43 mgKOH/g for FFA, 1.87-1.95 mgKOH/g for saponification value, 6.65-6.85 mgKOH/g for acid value, 1.443-1.455 for refractive index and 1.44-1.45 cm/sec. for viscosity.

**Keywords:** process conditions, physico-chemical properties, screw jack, groundnut oil, extraction.

Submitted: 14.09.2016

Reviewed: 28.10.2016

Accepted: 16.12.2016

### 1. INTRODUCTION

Groundnut (*Arachis hypogaea* L.) is a leguminous crop that is commonly grown for the extraction and utilization of the edible oil from its oily seeds (Prasad *et al.*, 2009). The oily seeds are eaten as snacks after roasting and are also used as feedstock for the production of groundnut oil; cakes obtained after oil extraction are used as raw materials for making animal feeds. Ranshankar *et al.*, (2007) reported groundnut as the world's numbers four and three most important source of edible oil and plant based protein respectively. Prasad *et al.*, (2009) reported that Nigeria, Congo, Senegal, Sudan and Niger Republic as some of the major countries that grow groundnut in large quantities in Africa. In terms of nutritional compositions, the oily seeds of groundnut contain oil, protein and carbohydrate in the range of values of 47% -53%, 25% - 36% and 10% - 15% respectively. The

extracted edible oil from groundnut seeds has calcium, sodium, potassium, phosphorus, magnesium, thiamine, vitamins E and B, selenium and zinc (Nkafamiya *et al.*, 2010 and Prasad *et al.*, 2009). Apart from the uses of edible plant based oils for cooking foods and their uses in confectionery industries, edible plant based oils can also be used as part of raw materials for the production of soap, paints, detergent and cosmetics (Wilfred *et al.*, 2010 and Bachmann, 2001).

In the extraction of plant based oils, some of the factors that can affect the final qualities of extracted oils are: methods of oil extraction (mechanical, traditional or manual, chemical and others); extraction process conditions (temperature, pressure, moisture content, processing time, particle size, concentration of chemical and so on); crop factors (type and variety of crop, maturity level of crop and storage history of the feedstock) and the level

of technical know-how of the operator of the oil extraction systems. Groundnut oil is one of the most readily available plant based oils because of the abundance and easy availability of groundnuts. The factors earlier listed when combined for extraction of groundnut oil can either have positive or negative effect on the final quality of extracted oil. Therefore, the objective of this study was to investigate the effect of two process conditions (temperature and heating time) on some physico-chemical properties (pH value, Free Fatty Acid (FFA), saponification value, acid value, refractive index and viscosity) of groundnut oil extracted with a vertical screw jack.

## 2. MATERIALS AND METHODS

The following equipment were used: a vertical screw jack (Figures 1 and 2), digital weighing balance (OHAUS CL Series, Model CL 201, China, accuracy: 0.1), stop watch (Nokia X2-01), and oil bottles and containers. Three levels of heating temperature (50°C, 60°C and 70°C) and two levels of heating time (5 min and 10 min) were used for processing the groundnut before oil extraction. The experimental design used was 3 × 2 factorial experiment in a Randomized Completed Block Design (RCBD) with three replicates. A uniform experimental sample of 100 g of prepared groundnut seeds was used as feedstock for oil extraction operation. After the extraction operation, all the oil samples were analysed for pH value, Free Fatty Acid (FFA), saponification value, acid value, refractive index and viscosity in accordance with AOAC (2002) standard procedures. With the data obtained from laboratory analysis of the physico-chemical properties, combined effect of temperature and heating time on the physico-chemical properties of groundnut oil samples extracted with the vertical screw jack were descriptively analysed and presented with histogram. The extraction operation was carried out at the Department of Agricultural and Biosystems Engineering workshop, University of Ilorin, Ilorin, Nigeria, and the analysis of physico-chemical properties of extracted groundnut oil

was done at the Chemistry Department, University of Ilorin, Ilorin, Nigeria.

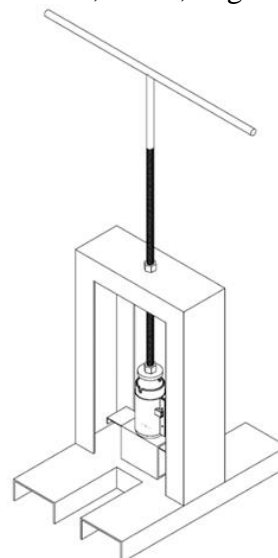

Figure 1: Isometric view of the vertical screw jack

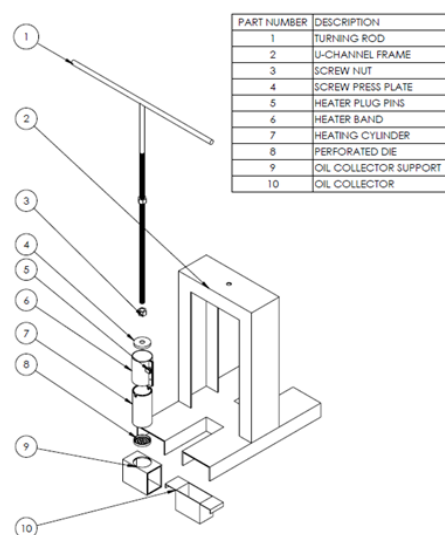

Figure 2: Exploded view of the vertical screw jack

## 3. RESULTS AND DISCUSSION

### 3.1 Effect of Temperature and Time of Heating on pH Value and Free Fatty Acid (FFA)

The effect of temperature and time of heating on pH value and FFA is shown in Figures 3 and 4 respectively. From Figure 3, it is clearly seen that increase in temperature and time of heating caused the pH value to drop from about 5.37 to about 5.05 but later increased to a highest value of about 5.45 at 70°C temperature and 10 min time of heating. The highest pH value of 5.45 obtained could mean that the

groundnut oil extracted with the screw jack would be self-preserving. Muibat *et al.*, (2011) and Akinoso *et al.*, (2006) reported 6.20 and 6.0 pH values respectively for oil extracted from *Telfairia occidentalis* and palm kernel. Figure 4 shows that the free fatty acid of groundnut oil decreases with increase in temperature from 50°C to 60°C but later increased to highest value at 70°C and heating times. The highest free fatty acid value obtained was slightly above 3.42 mg/KOH/g which was close to 3.48Mg/KOH/g reported by Muibat *et al.*, (2011) for *Telfairia occidentalis* oil. Also, the highest free fatty acid obtained was close to 3.45 mg/KOH/g reported by Akinoso *et al.*, (2006) for palm kernel oil and was greater than between 0.61-0.62 mgKOH/g reported by Usman *et al.*, 2015 for Oleander oil.

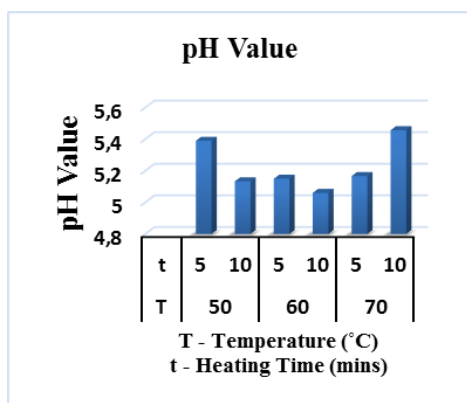

Figure 3: Effect of temperature and time of Heating on pH value

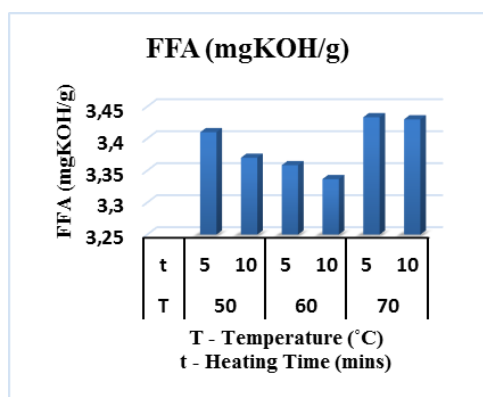

Figure 4: Effect of Temperature and time of heating on Free Fatty Acid (FFA)

### 3.2 Effect of Temperature and Time of Heating on Saponification value and Acid Value

Figures 5 and 6 respectively show the effect of temperature and time of heating on saponification value and acid value on the groundnut oil. The saponification values decrease from 50°C to 60°C but later increased to 194 mg/KOH/g at 70°C temperature and 5 min heating time.

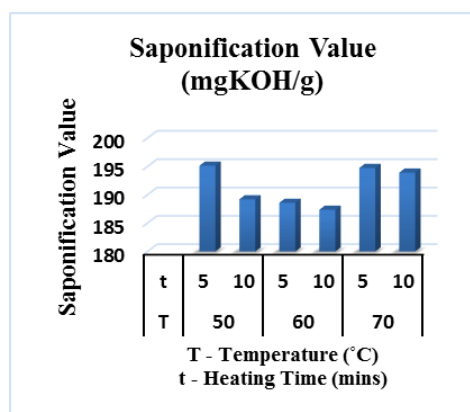

Figure 5: Effect of temperature and time of heating on saponification value

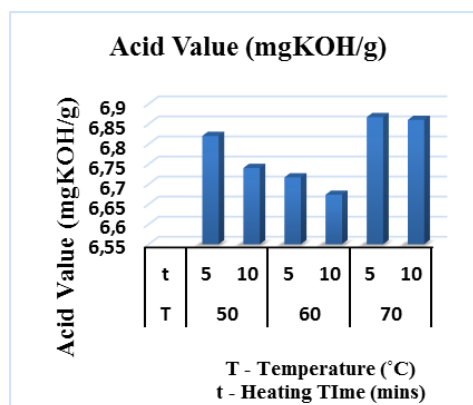

Figure 6: Effect of temperature and time of heating on acid value

However, the highest value of saponification value obtained was 195 mg/KOH/g and was at 50°C temperature and 5 min heating time. In all, the range of saponification value obtained was between 187 – 195 mg/KOH/g; this was higher than 162 mg/KOH/g reported by Nwabanne 2012 for oil extracted from fluted pumpkin seed with n-hexane as the extraction solvent. This value was greater than between 121.7-124.3 mgKOH/g obtained by Usman *et al.*, 2015 for Oleander oil. From Figure 6, the trend for acid value is also very similar to that

of saponification value. The highest acid value of 6.86 mg/KOH/g was obtained at 70°C temperature and 5 min heating time. This acid value obtained was higher than 6.70 mgKOH/g reported by Odewole *et al.*, (2015) for oil chemically extracted from fluted pumpkin seed with petroleum ether.

### 3.3. Effect of Temperature and Time of Heating on Refractive index and Viscosity

The effect of temperature and time of heating on refractive index and viscosity is as shown in Figures 7 and 8 respectively.

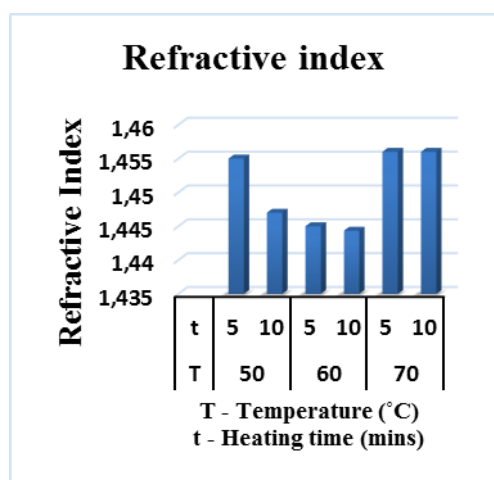

Figure 7: Effect of temperature and time of heating on refractive index

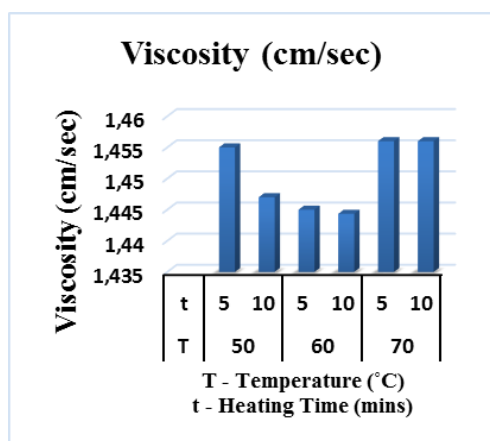

Figure 8: Effect of temperature and time of heating on viscosity

From the two figures, the refractive index and viscosity decrease in their values with increase in temperature from 50°C to 60°C, but later increase at 70°C. The value of refractive index of the extracted groundnut oil with the

screw jack was in the range of 1.43-1.450, which is close to (1.54-1.49) obtained by Eckey, 1954 for some fats in the nuts family. The highest value of refractive index of 1.46 was obtained at 70°C and 5 min and 10 min heating times; this value was very close to about 1.461 obtained by Usman *et al.*, (2009) for oleander oil. The effect of temperature and time of heating on viscosity is shown in Figure 8. From the figure, it is shown that the level of viscosity decrease and later increase at the highest level of temperature. The range obtained was 1.44-1.45 cm/sec. Odewole *et al.*, (2015) obtained close 2.0 cm/sec for fluted pumpkin oil extracted by solvent extraction.

### 4. CONCLUSIONS

All the physico-chemical properties decreased with increase in temperature from 50°C to 60°C and heating times but later increased at 70°C. The range of physico-chemical properties obtained were: 5.05-5.45 for pH value, 3.32-3.43 mgKOH/g for FFA, 1.87-1.95 mgKOH/g for saponification value, 6.65-6.85 mgKOH/g for acid value, 1.443-1.455 for refractive index and 1.44-1.45 cm/sec for viscosity. More process conditions and their higher levels as well as qualities of groundnut oil extracted with the screw jack under long time storage conditions should be considered.

### REFERENCES

- [1] Akinoso, R., Igbeka, J.C., Olayanju, T.M.A and Bankole, L.K. Modelling of Oil Expression from Palm Kernel (*Elaeis guineensis Jacq.*). Agricultural Engineering International: The CIGR Ejournal. **Volume 8**. (2006), pp. 1-8.
- [2] AOAC. Official methods of Analysis Association of Analytical Chemists, Washington D.C.(2002).
- [3] Bachmann Janet. Small-Scale Oilseed Processing. ATTRA Value-Added and Processing Guide. Appropriate Technology Transfer for Rural Areas ATTRA (2001) pp. 1-24
- [4] Eckey, E.W. Vegetable Fats and Oils, Reinhold publishing co. New York, (1954), pp. 407- 426.
- [5] Muibat O.B., Temitope L.A., Deborah O.A. and Abdulkabir O.O. Physicochemical Properties and Fatty Acids Profile of Seed Oil of Telfairia occidentalis Hook, F. International Journal of Basic and Applied sciences **Volume 11** No.6, (2011) pp. 10-13.
- [6] Nkafamiya I.I., Maina H.M., Osemehon S.A. and Modibbo U.U. Percentage Oil Yield and Physiochemical Properties of different Groundnut

Species (*Arachis hypogaea*). African Journal of Food Science. **Volume 4** No.7, (2010) pp. 418 – 421.

[7] Odewole, M.M., Sunmonu, M.O., Obajemihi, O.I and Owolabi, T.E. Extraction of Oil from Fluted Pumpkin Seed (*Telfairia Occidentalis*) by Solvent Extraction Method. Annals. Food Science and Technology (AFST) Journal. **Volume 16** No 2, (2015) pp. 372-378.

[8] Prasad, P.V.V., Kakani, V.G., Upadhyaya, H.D. Growth and production of Groundnut, in Soils, Plant Growth and Crop Production, [Ed. Willy H. Verheye], in Encyclopedia of Life Support Systems (EOLSS), Developed under the Auspices of the UNESCO, Eolss Publishers, Oxford, UK, [http://www.eolss.net] [Retrieved September 14, 2016] (2009) pp. 1-30

[9] Ranshankar K., Sreejith K.P., Nigam S.N., Aruna R. and Yadagiri D. Groundnut Gourmet. International crop research Institutes for Semi-Arid tropics (ICRISAT) Publication 49. (2007)

[10] Usman, L.A., Oluwaniyi, O.O., Ibiyemi, S.A., Muhammad, N.O. and Ameen, M.O. The Potential of Oleander (*Thevetia peruviana*) in Africa Industrial Industry Development: A Case Study of Nigeria. Journal of Applied Biosciences **Volume 24**, (2009) pp.1477-1487.

[11] Wilfred S., Adubofuor J. and Oldham J.H. Optimum Conditions for Expression of oil from *Allanblackia floribunda* Seeds and Assessing the Quality and Stability of Pressed and Solvent Extracted oil. African Journal of Food Science **Volume 4** No.9, (2010) Pp. 563 – 570.